

“Book Smartz” with Club UYN!

Use a grocery bag and these NetSmartz cut-outs to make the coolest book cover ever!!

You will need:

- 1 Book
- 1 Brown paper grocery bag
(Make sure it's big enough to cover your book!)
- Crayons
- Glue or a glue stick

- NetSmartz character cut-out pages (2)
- Pencil
- Scissors

Your trusted adult!

Instructions :

1. Print the NetSmartz character cut-outs. Color and cut them out.
2. Cut down the side of the bag. Then cut off the bottom. You will have a long rectangle.
3. Open your book and put it in the center of the paper. Draw a line along the top and the bottom of your book.

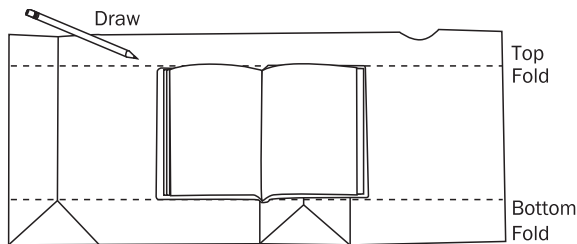

Step 3

4. Remove your book and fold the paper along these lines. Make sure the paper covers your book from top to bottom.
5. Now, place your book on top of the folds. Draw a line along the left and right sides of the book.

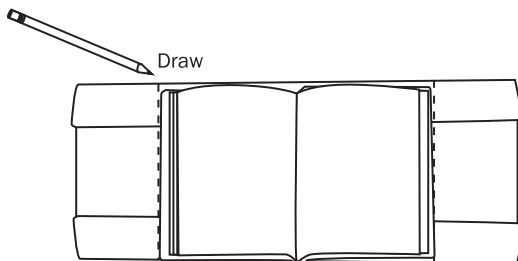

Step 5

6. Fold the paper along the lines to make a crease.

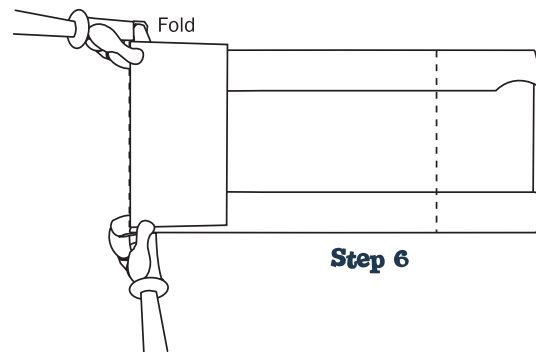

Step 6

7. Slide each side into the opening created by the two folds.

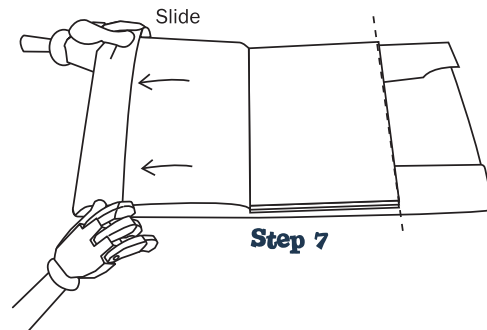

Step 7

8. Take your NetSmartz character cut-outs and glue them onto the cover however you want. Now even your books can show-off their NetSmartz!

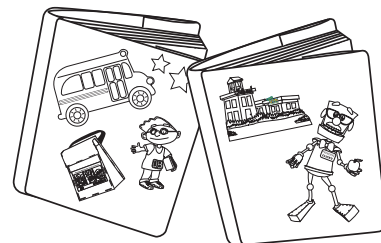

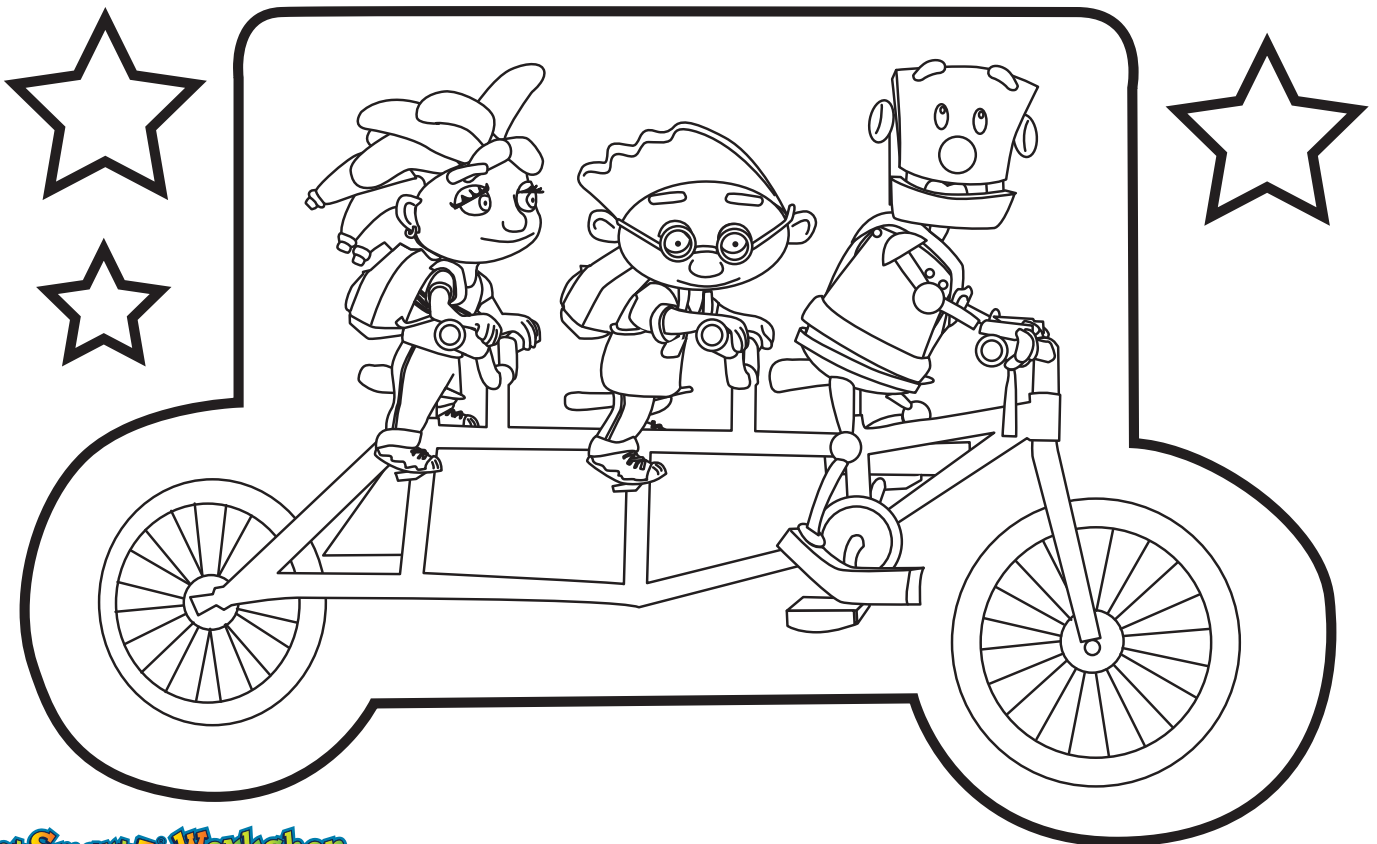
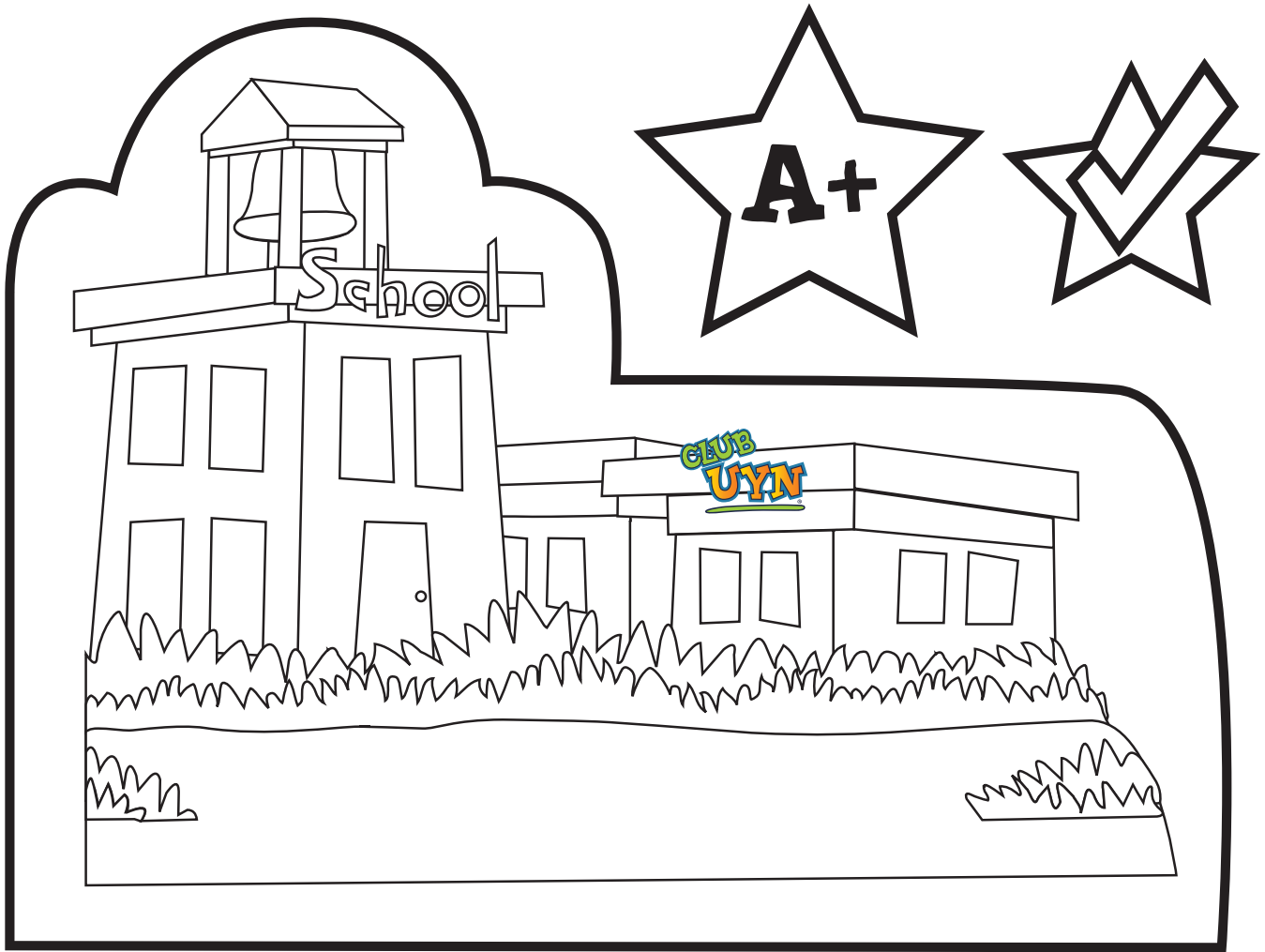

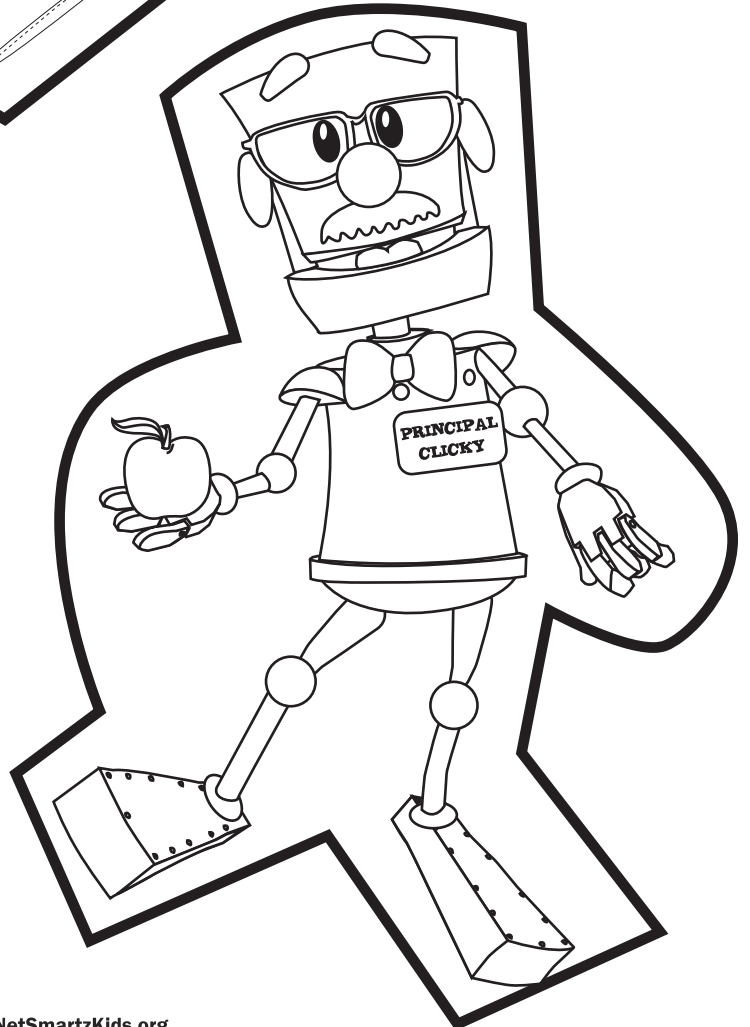
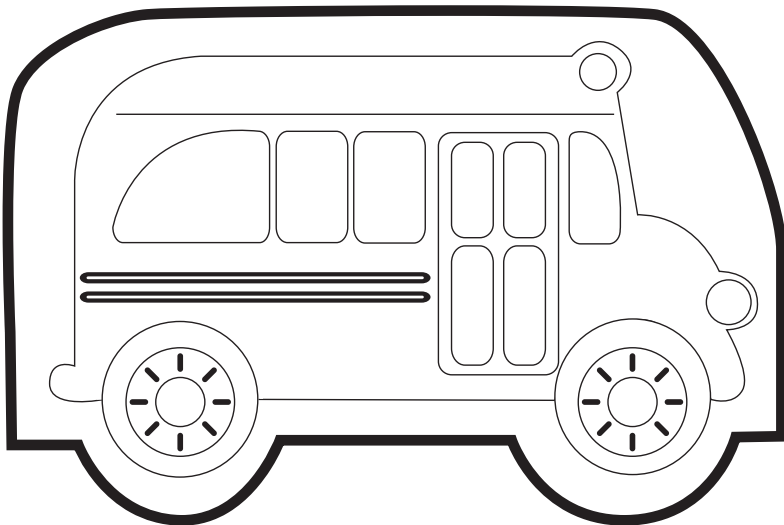
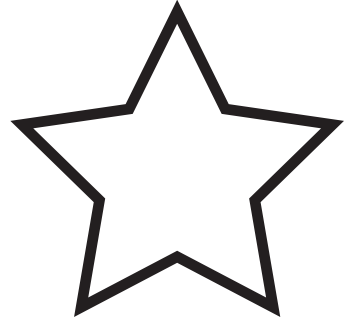
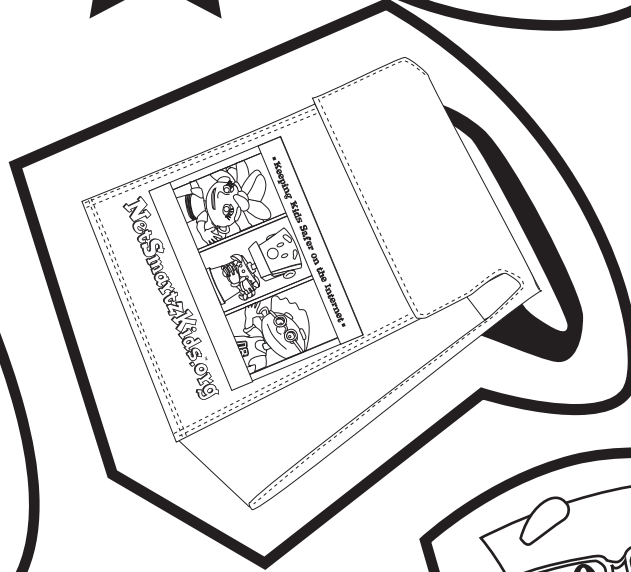
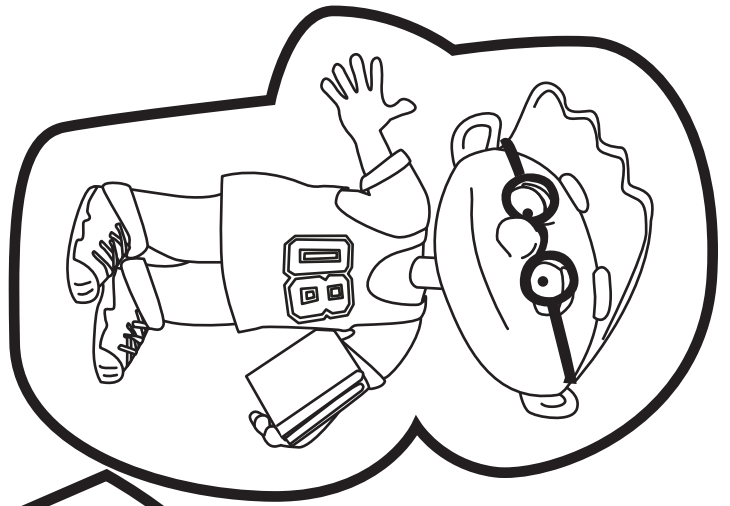
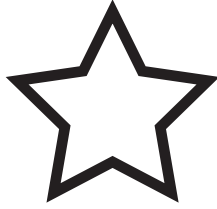



Share with Clicky!

Mail your activity to:

NCMEC-NetSmartz Workshop

Attn: Club UYN

699 Prince Street

Alexandria, VA 22314

or

E-mail a picture or scanned copy of it to:

clicky@netsmartzkids.org

Include your parent's or guardian's e-mail to be featured
in the **Hall of Fame**.